

**change your
thinking**



@KieranFTII

**unprecedented
change**



7 Things You Need To Know About The New Facebook Page Layout



@thinkKieranf



**we bias to
the negative**

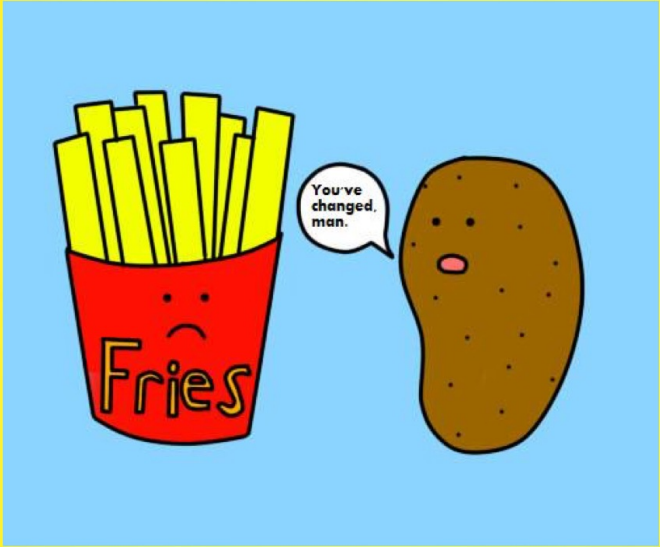

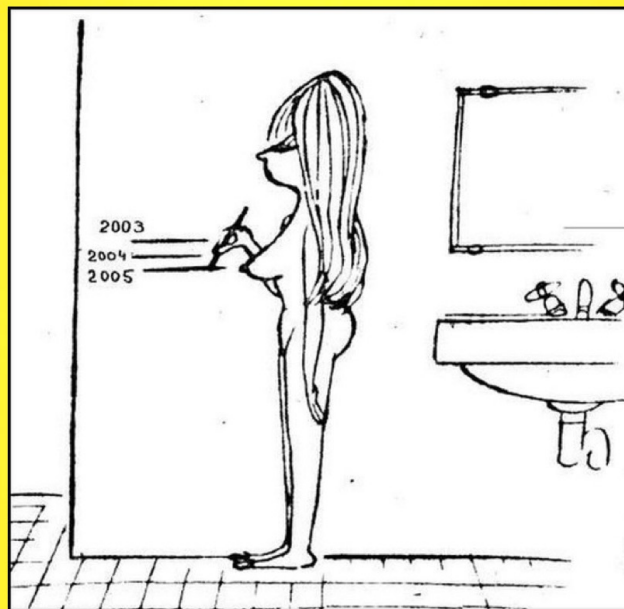



loss aversion

**Pain of loss >
pleasure of gains**

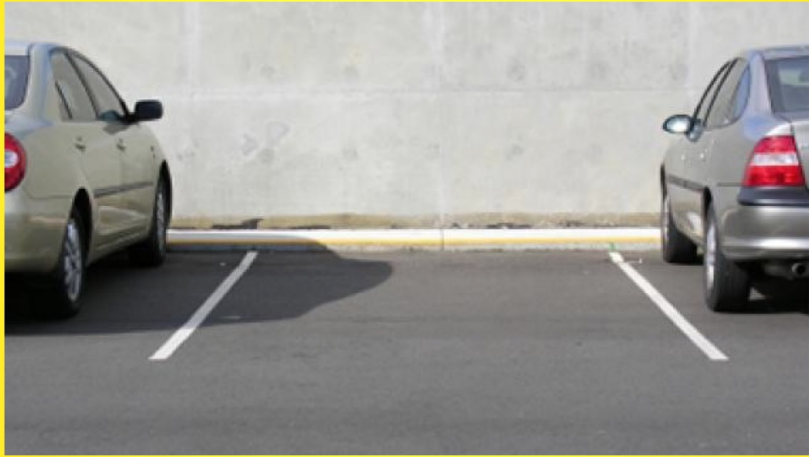

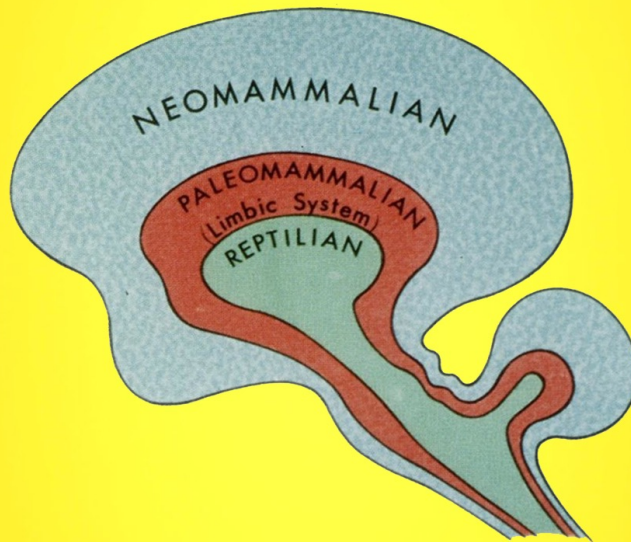



**change your
thinking
about change**

@KieranFTII

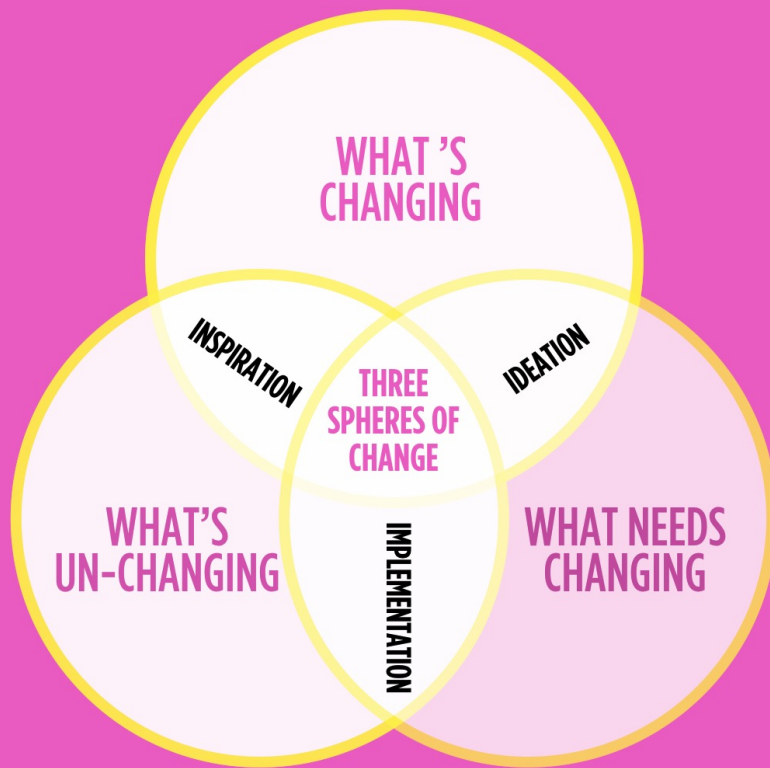



**WHAT'S
CHANGING**



**WHAT NEEDS
CHANGING**



**WHAT'S
UN-CHANGING**

**change your thinking
about creativity**

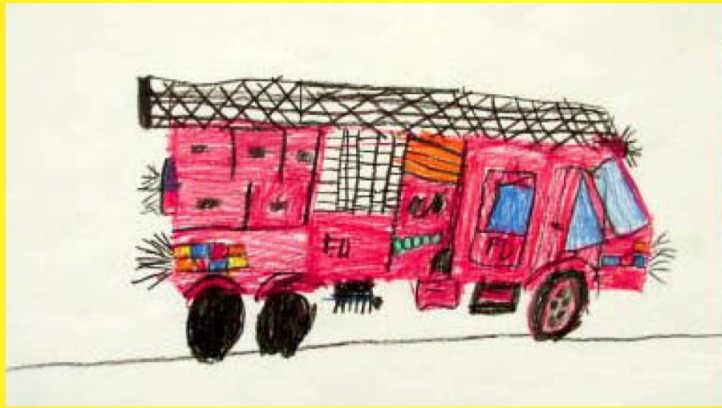

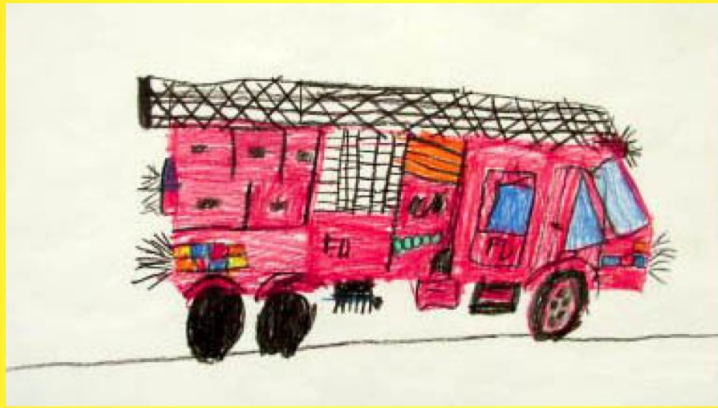

I'VE NEVER SEEN A FIRE ENGINE THAT NEEDED TO BE SHAVED. I WOULD RATHER BE BURNED TO DEATH THAN BE SAVED BY THIS HAIRY PIECE OF CRAP.





**CREATIVITY IS
NOT JUST
ARTISTRY**

**CREATIVITY IS
AN ABILITY
TO THINK**



INGENUITY

ADAPTABILITY

PROBLEM SOLVING

RESPONSIVENESS

INVENTIVENESS

AGILITY

FLEXIBILITY





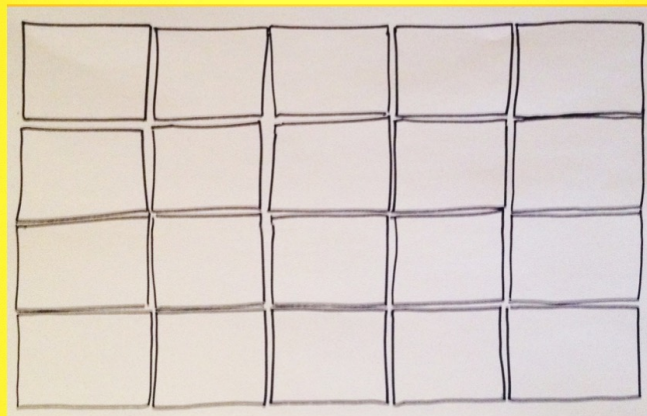

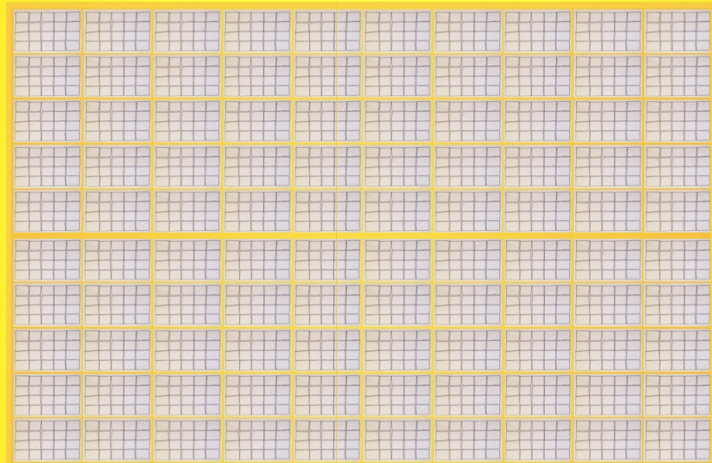

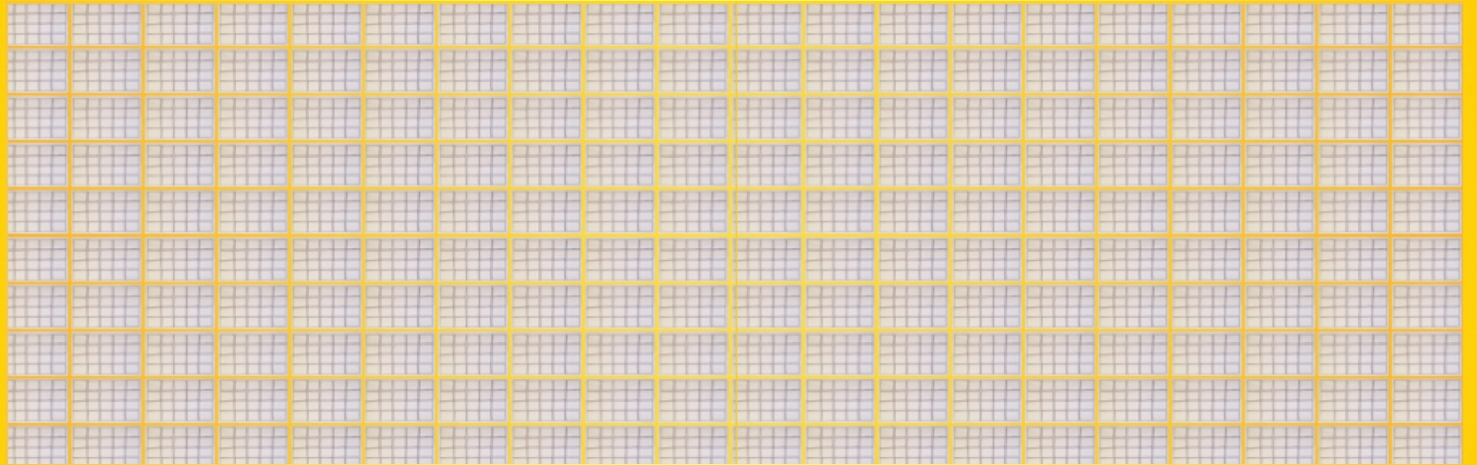





**change your thinking
about selling**

**Give
PEAS**

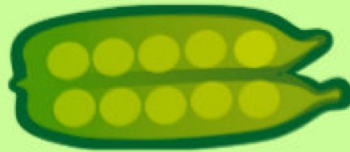

**a
CHANCE**

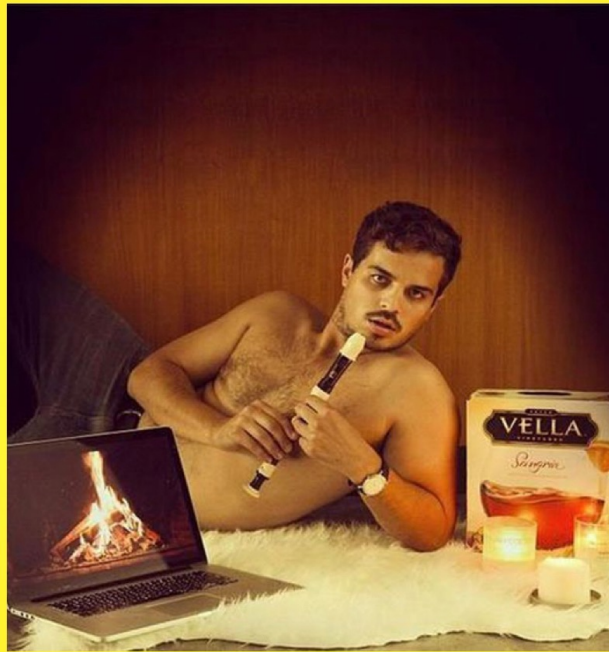



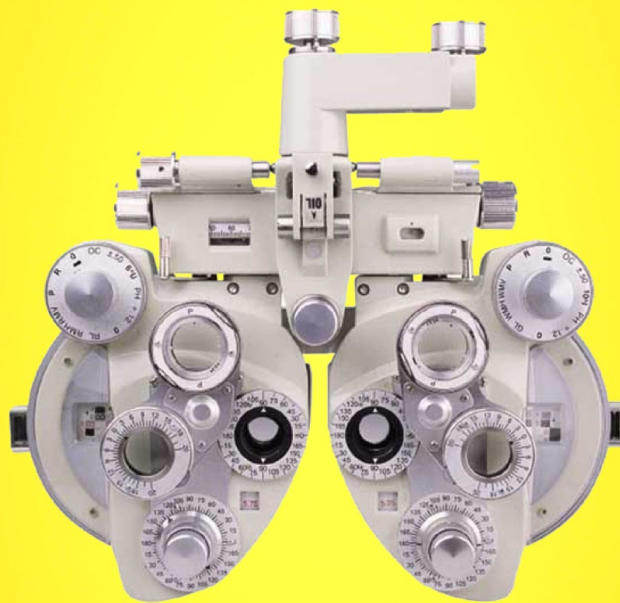





Just how sorry are you?

Pattinson's Florist
since 1923

215 Rowe St, Eastwood 2122 - PHONE (02) 9804 6244 - FAX (02) 9804 6877



**change your thinking
about collaboration**

NOTICE

**INTOLERANCE
WILL NOT BE
TOLERATED.**



**Massachusetts
Institute of
Technology**

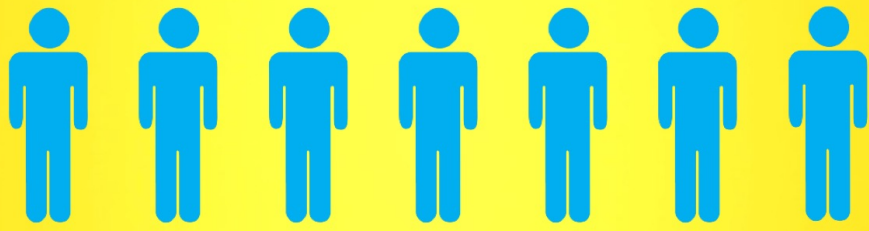

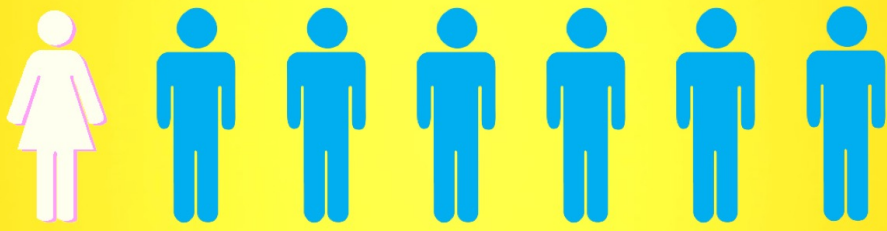

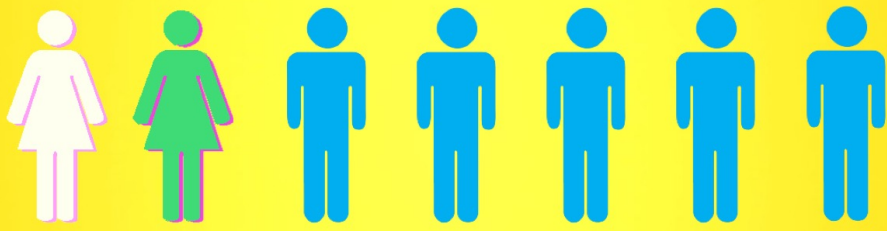

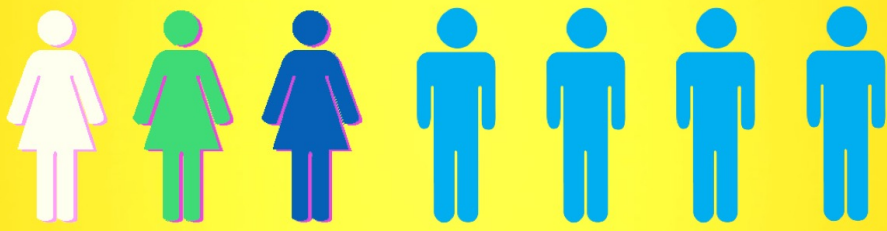

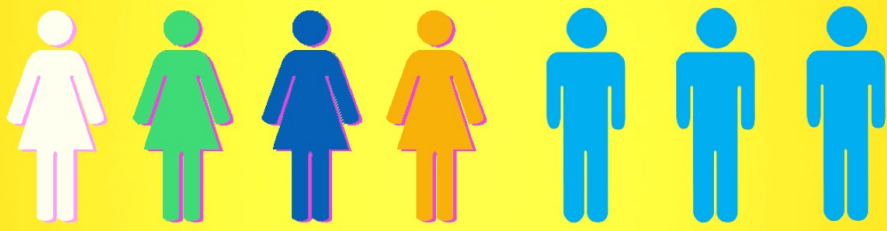

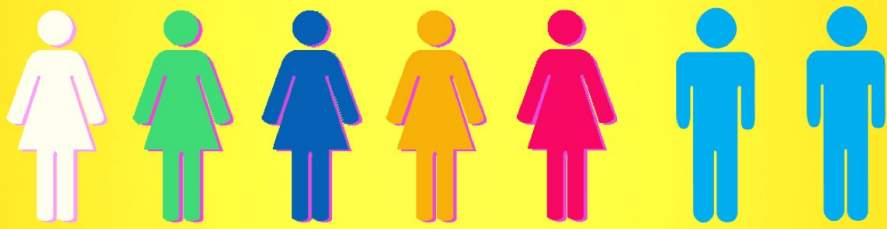

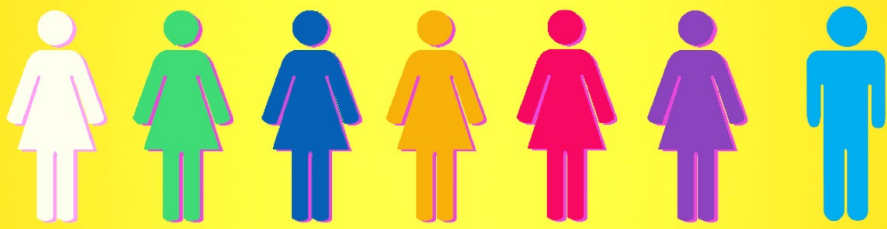

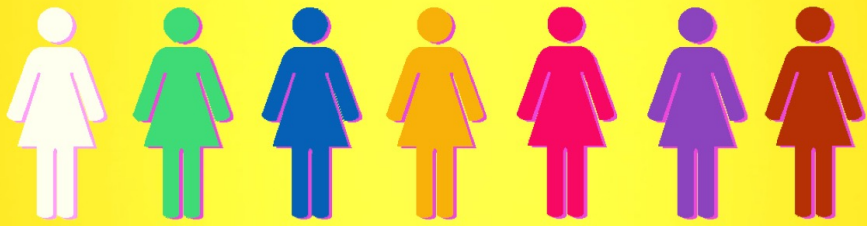



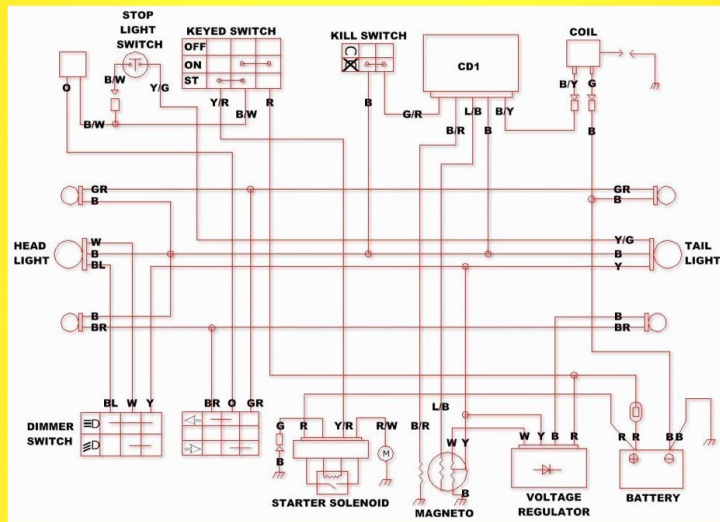

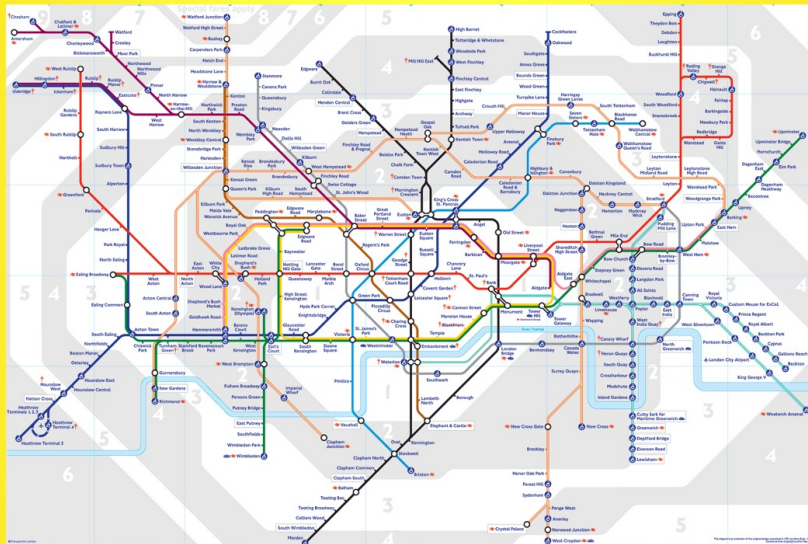

A white pillow is shown against a yellow background. The pillow has a green rectangular area on its left side. Printed on the white surface of the pillow is the following text:

THIS IS A TONTINE FRESH PILLOW.
WITH NORMAL USE WE SUGGEST CHANGING IT BY
APRIL 2013

**change your thinking
about motivation**







**CHANGE YOUR
THINKING.
CHANGE
EVERYTHING**

THANK YOU
kieranflanagan.com

